

2

1

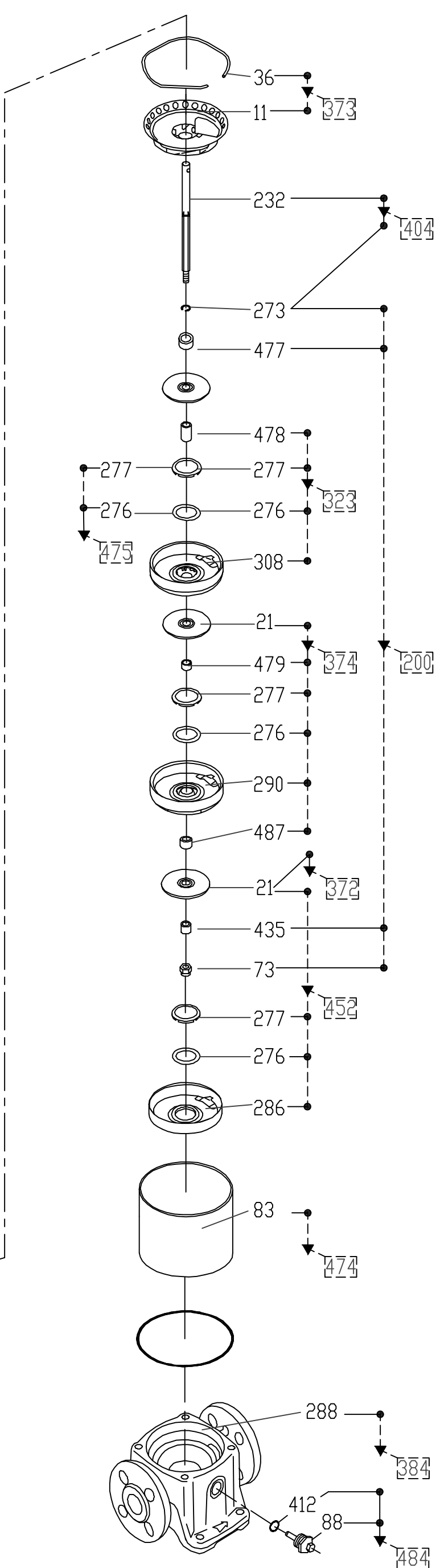
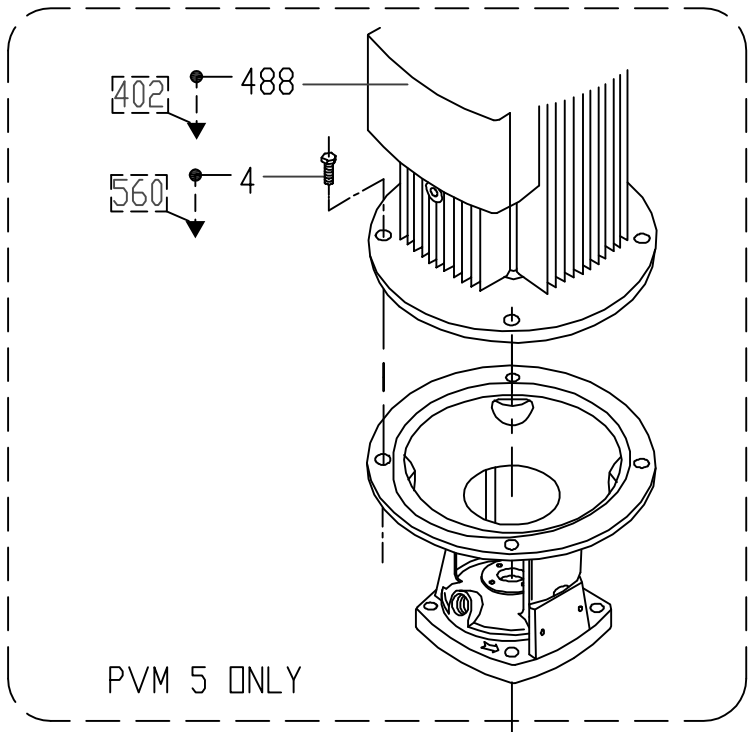

B

B

A

A



Pentair Water Italy S.r.l.  
Via Masaccio,13  
56010 Lugnano (PI)  
ITALY

Drawn R.De Ieso

Title PVM 1-3-5

Sheet 1:1

Approved -

Date (dd/mm/yy) 23.06.2015

Dwg #

DR150007

2

1

This drawing is the absolute property of Pentair Water Italy S.r.l. It may not be reproduced in any form without the written permission of Pentair Water Italy S.r.l.

B

B

A

A

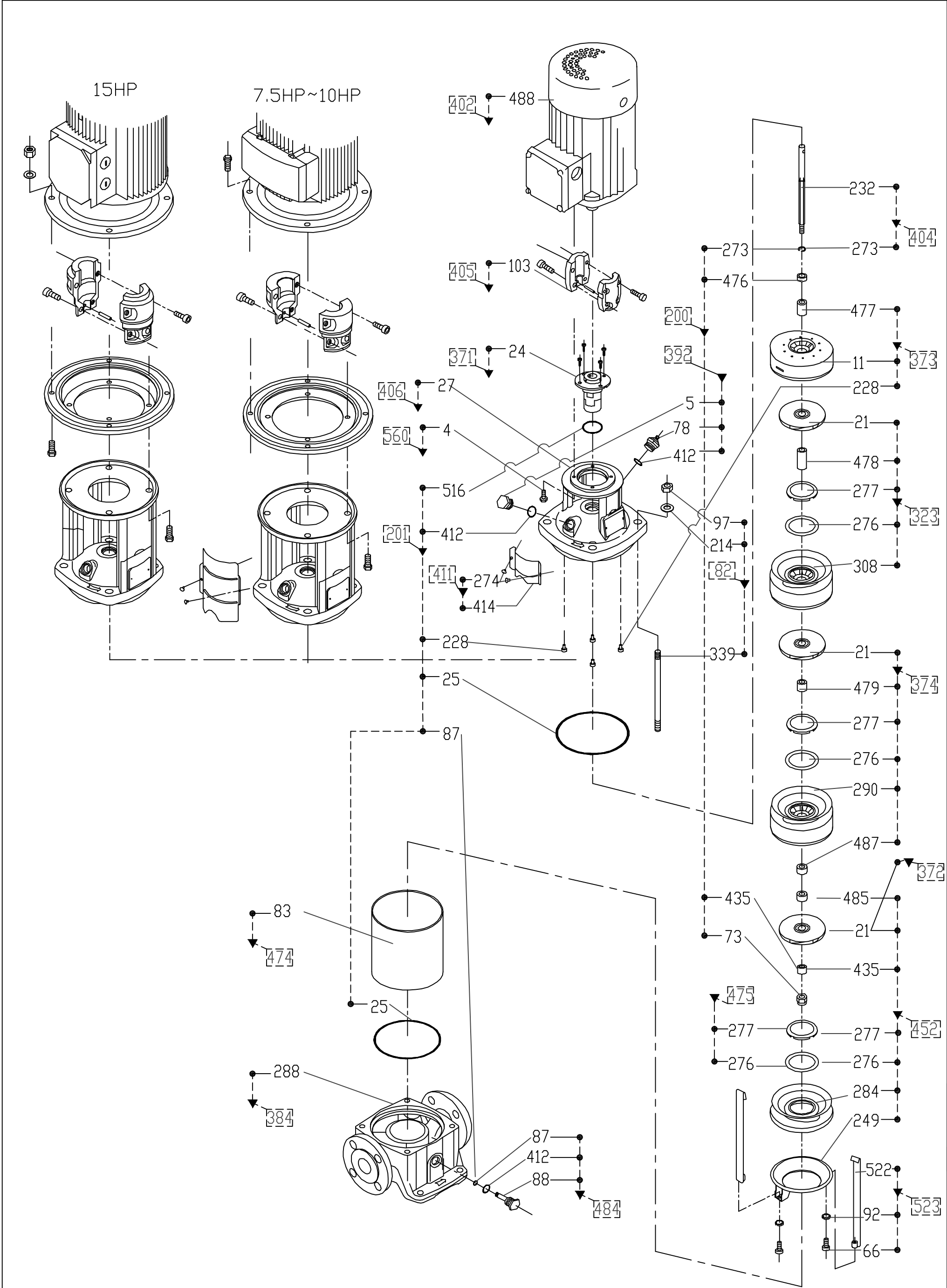

Pentair Water Italy S.r.l.  
Via Masaccio,13  
56010 Lugnano (PI)  
ITALY

Drawn R.De Ieso  
Approved 30.06.2015

Title PVM 10-15-20  
Date (dd/mm/yy) -  
Dwg #

Sheet 1:1  
DR150008

This drawing is the absolute property of Pentair Water Italy S.r.l. It may not be reproduced in any form without the written permission of Pentair Water Italy S.r.l.

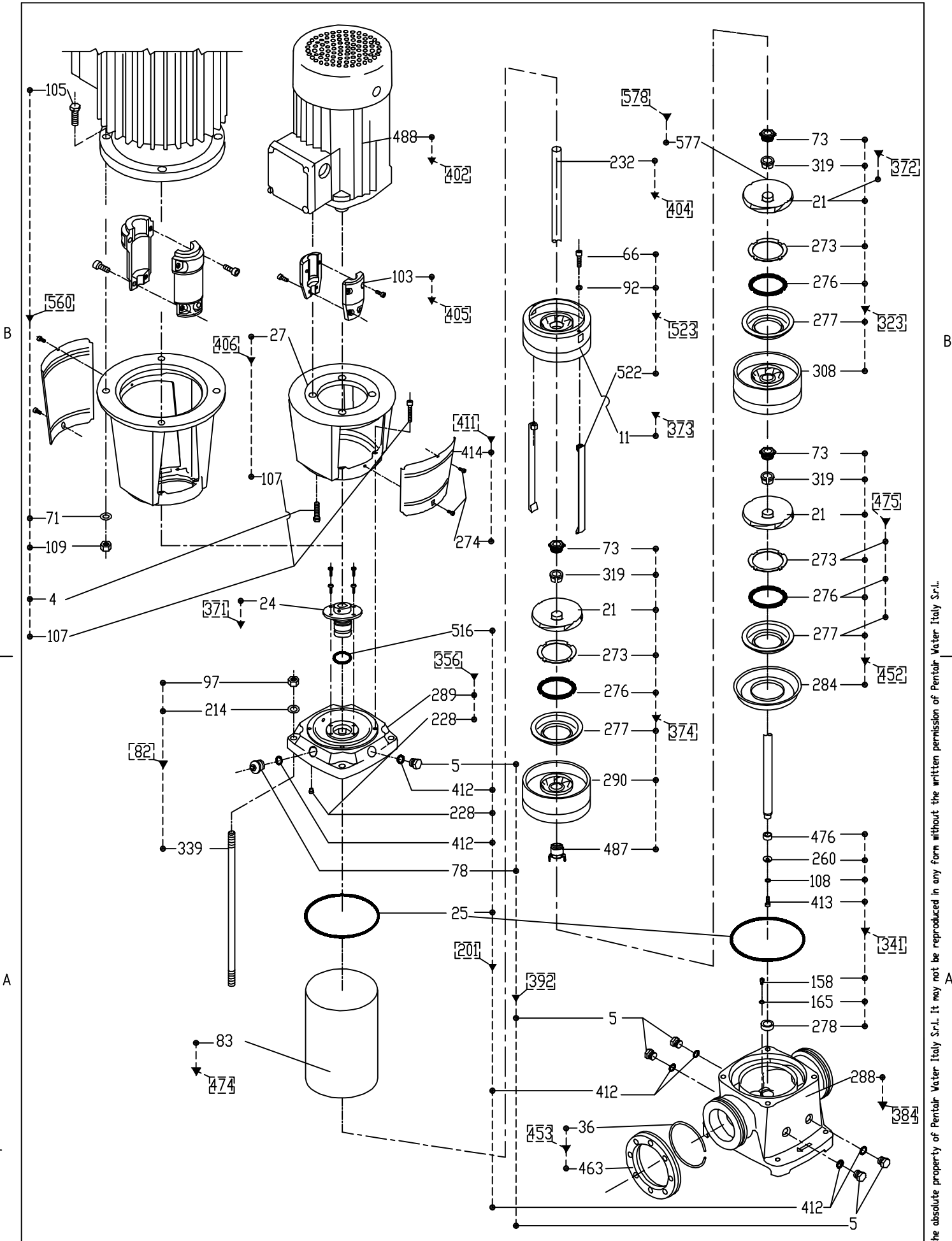

<small>C:\Users\2287447\Desktop\Fant 201\Pentair_Lupo_PSE_Bookings</small> Pentair Water Italy S.r.l. Via Masaccio,13 56010 Lugnano (PI) ITALY	Drawn	R.De Ieso	Title		PVM 32/45/64/90	Sheet	11
	Approved	PAPESCHI	Date (dd/mm/yy)	Dwg #	02.07.2015	DR150009_02	

This drawing is the absolute property of Pentair Water Italy S.r.l. It may not be reproduced in any form without the written permission of Pentair Water Italy S.r.l.

# Drawing For Parts List

# PVM-120, 150

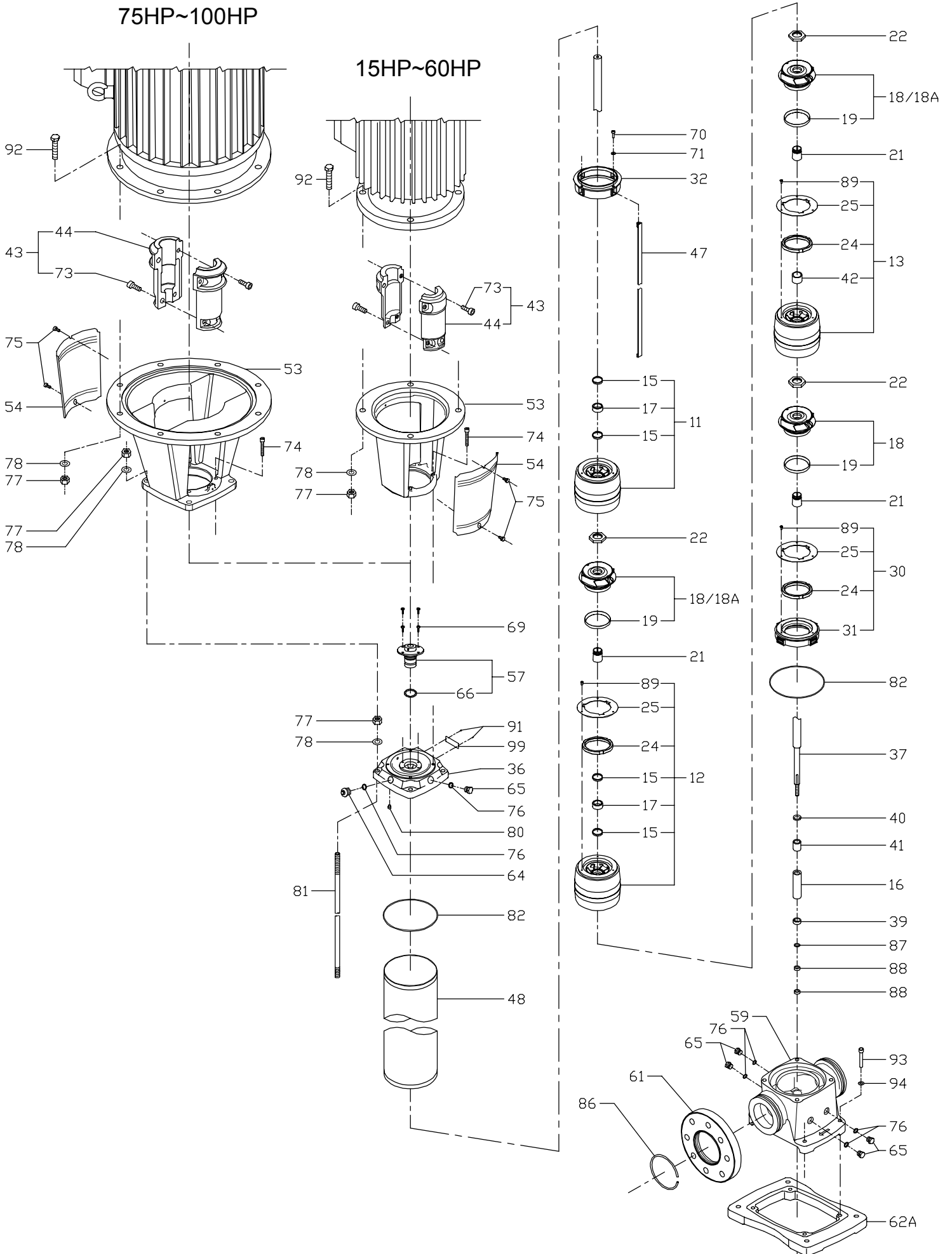

# Drawing For Parts List

# PVMI-120, 150

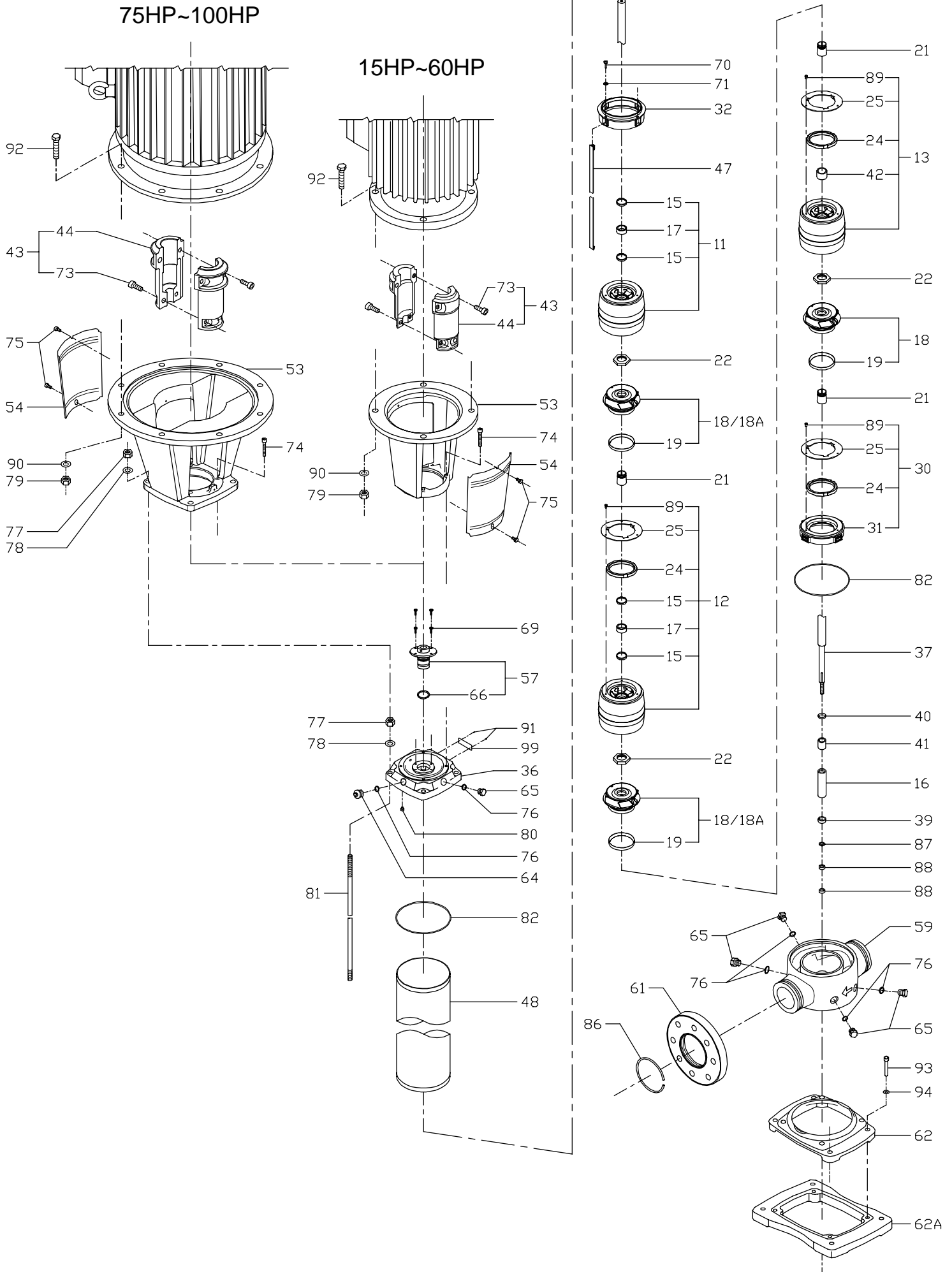

# Drawing For Parts List

# PVMI-PVMX-1, 3

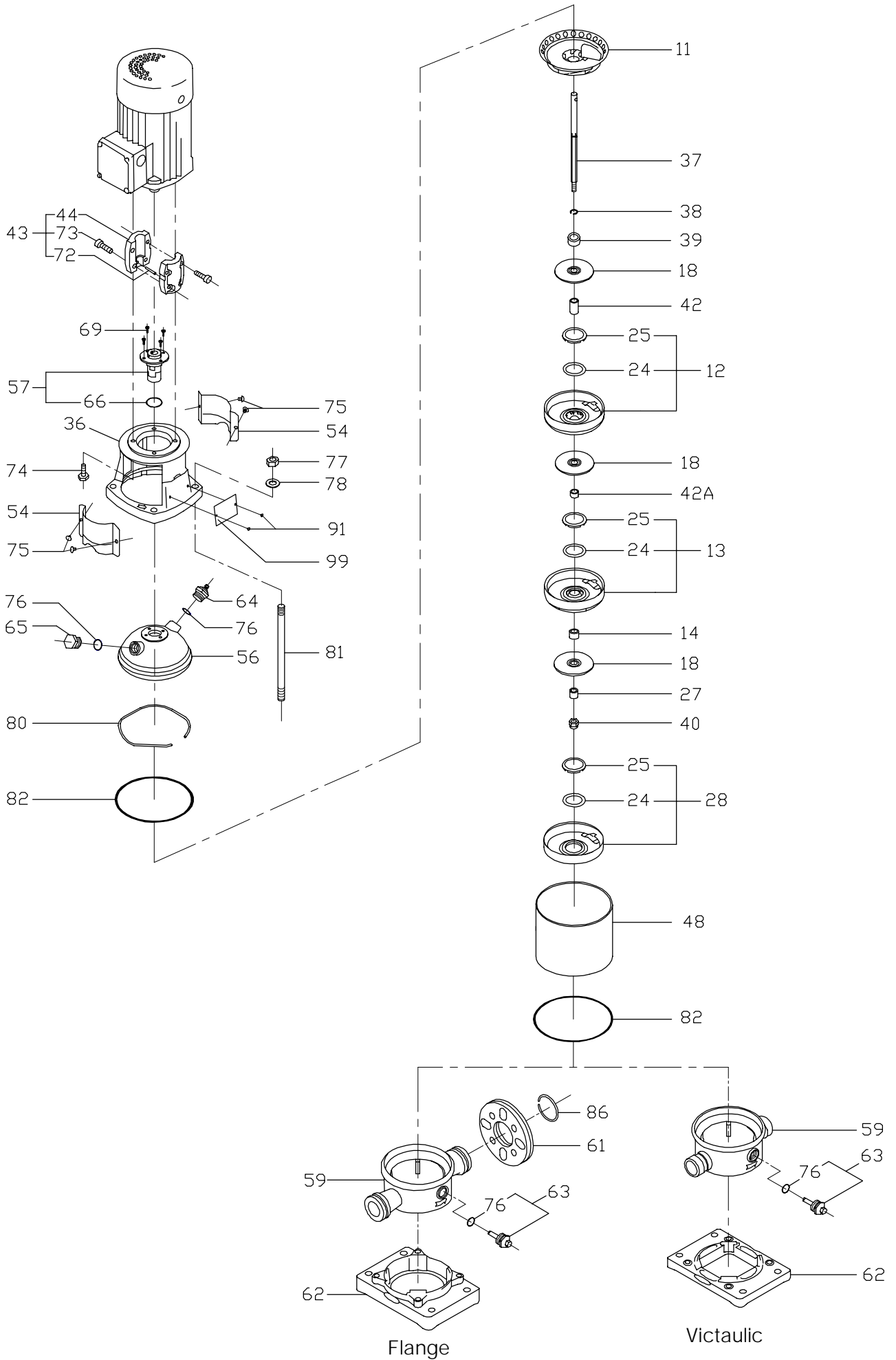

# Drawing For Parts List

# PVMI-PVMX-5

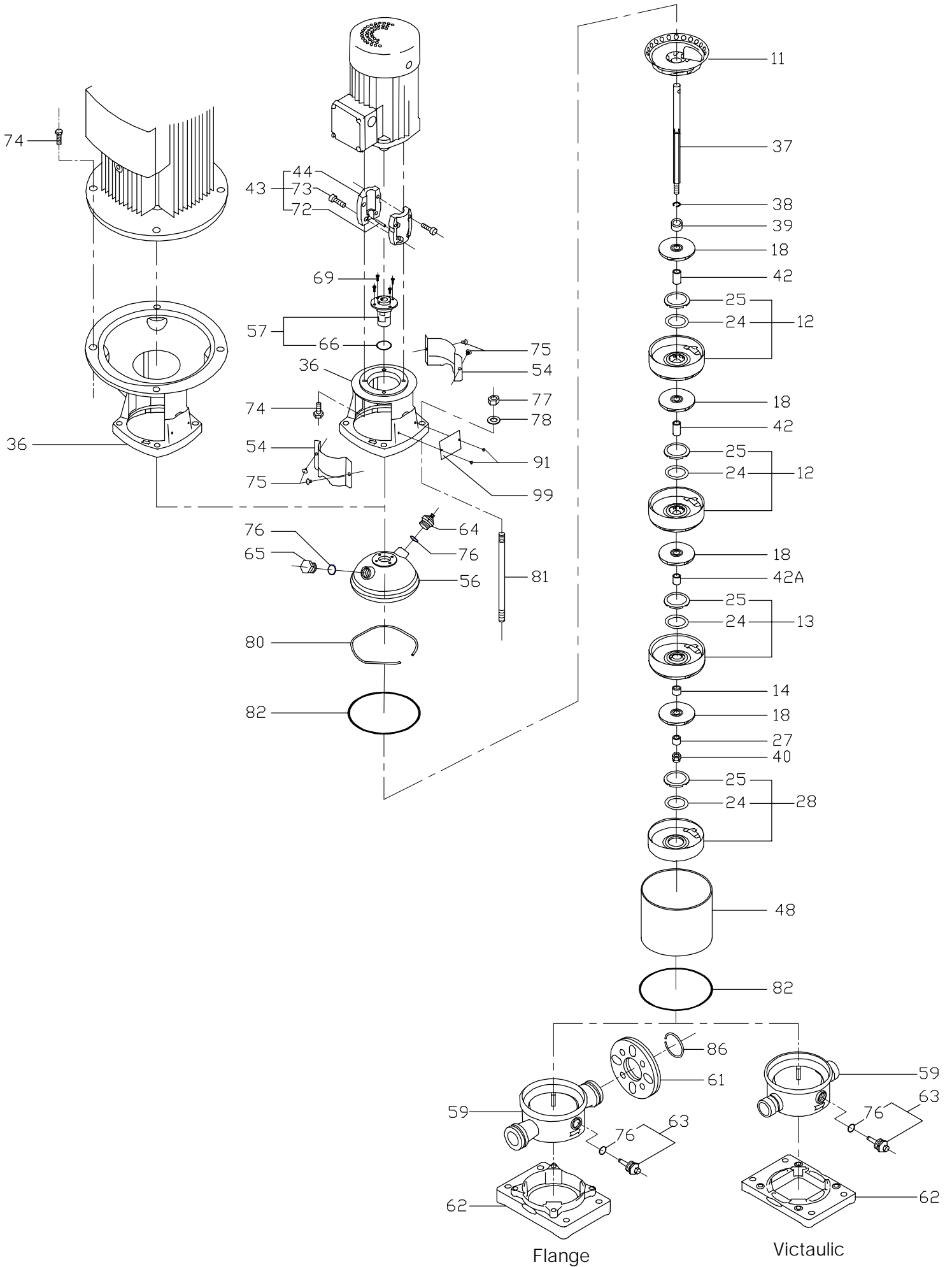

# Drawing For Parts List

# PVMI-PVMX-10

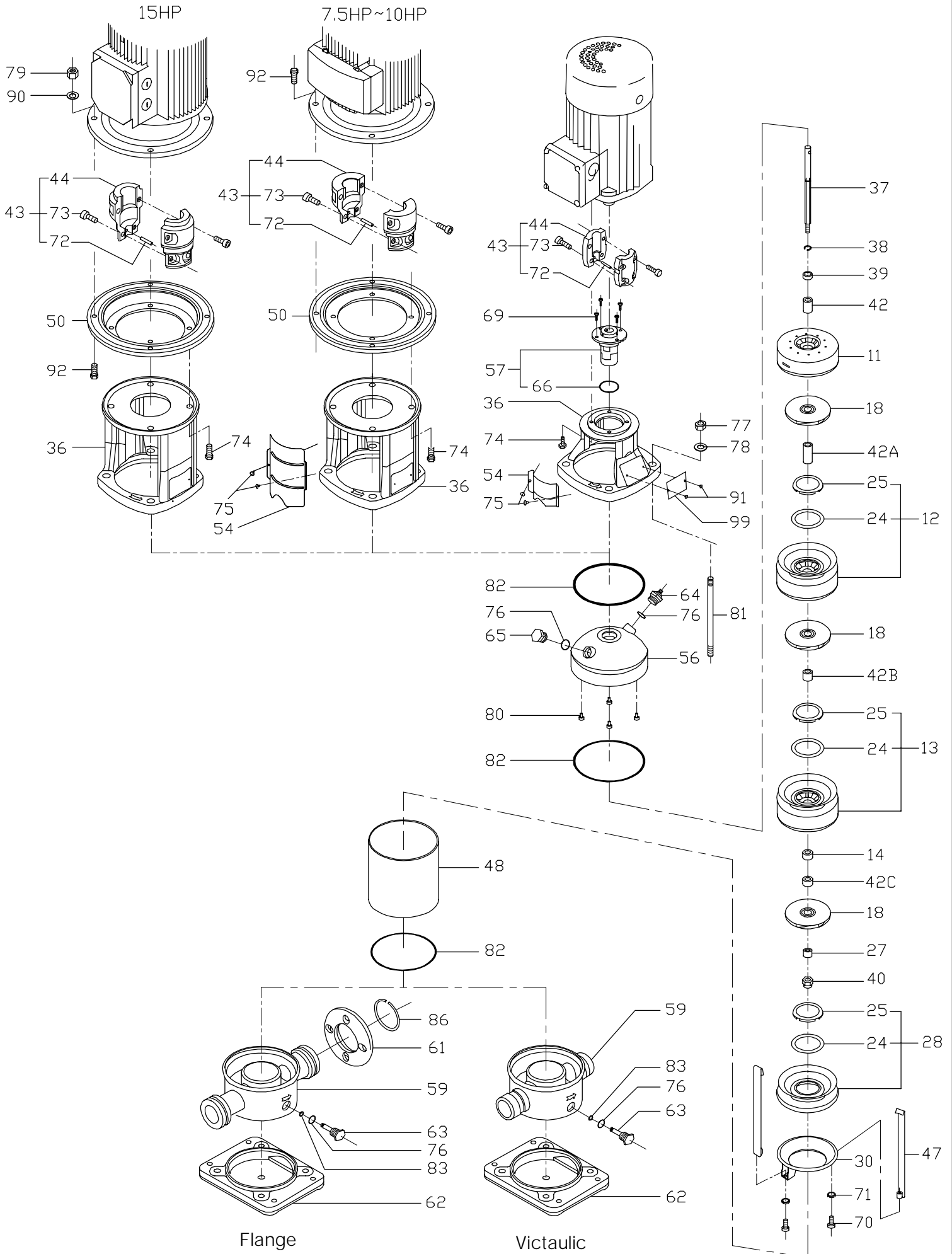



# Drawing For Parts List

# PVMI-PVMX-15, 20

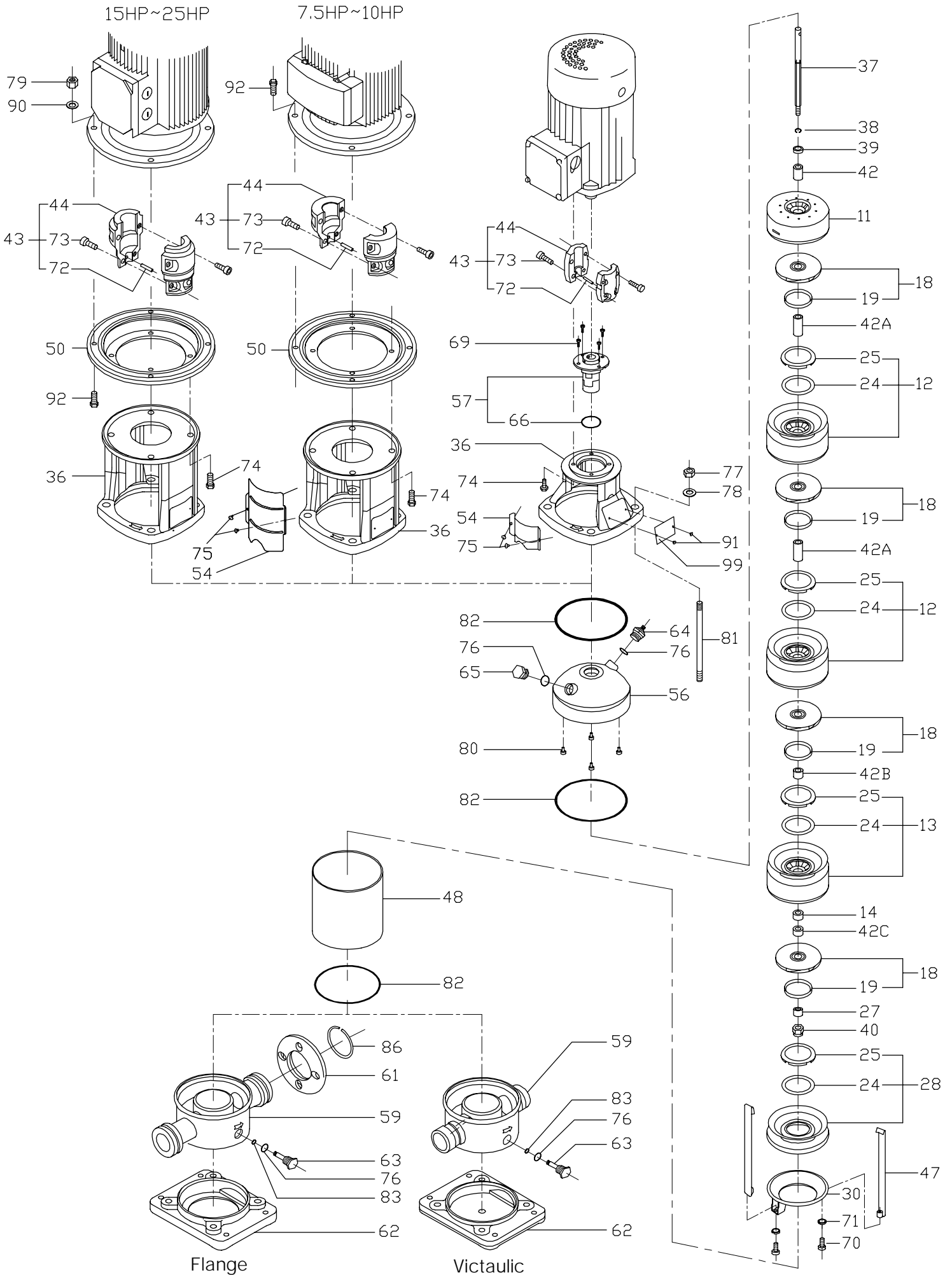

# Drawing For Parts List

# PVMI-PVMX-32

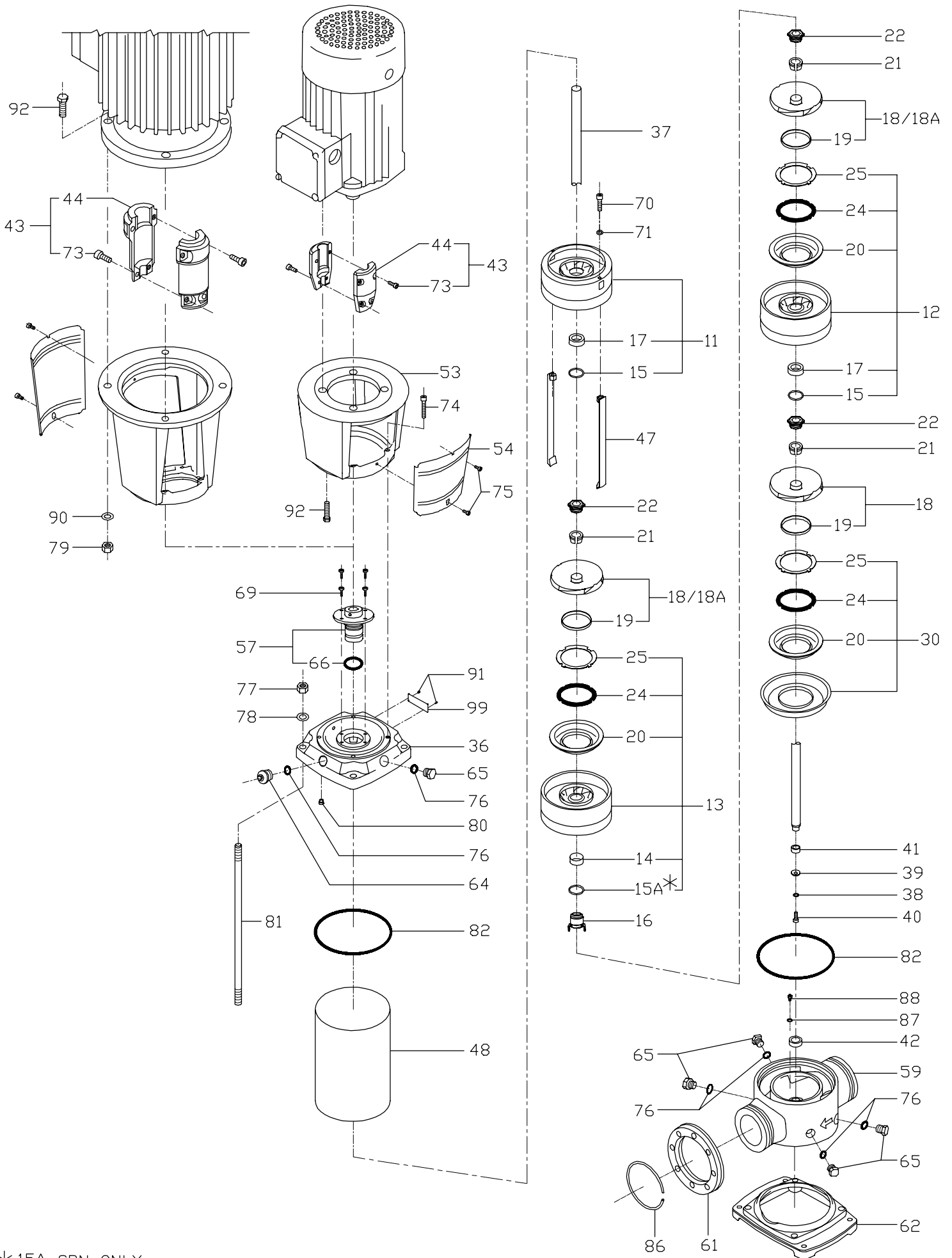

\*15A SBN ONLY

# Drawing For Parts List

# PVMI-PVMX-45

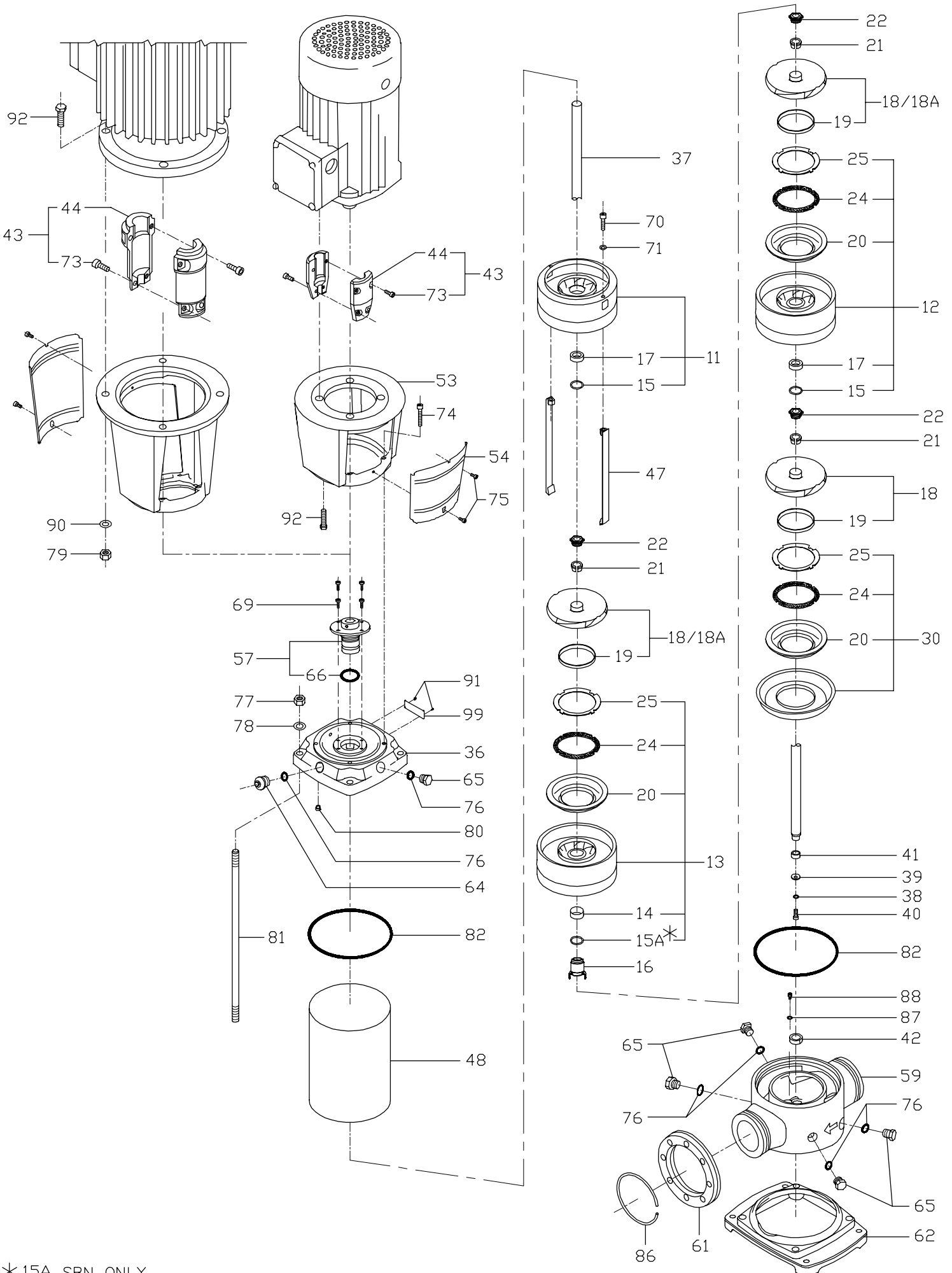

\*15A SBN ONLY

# Drawing For Parts List

# PVMI-PVMX-64

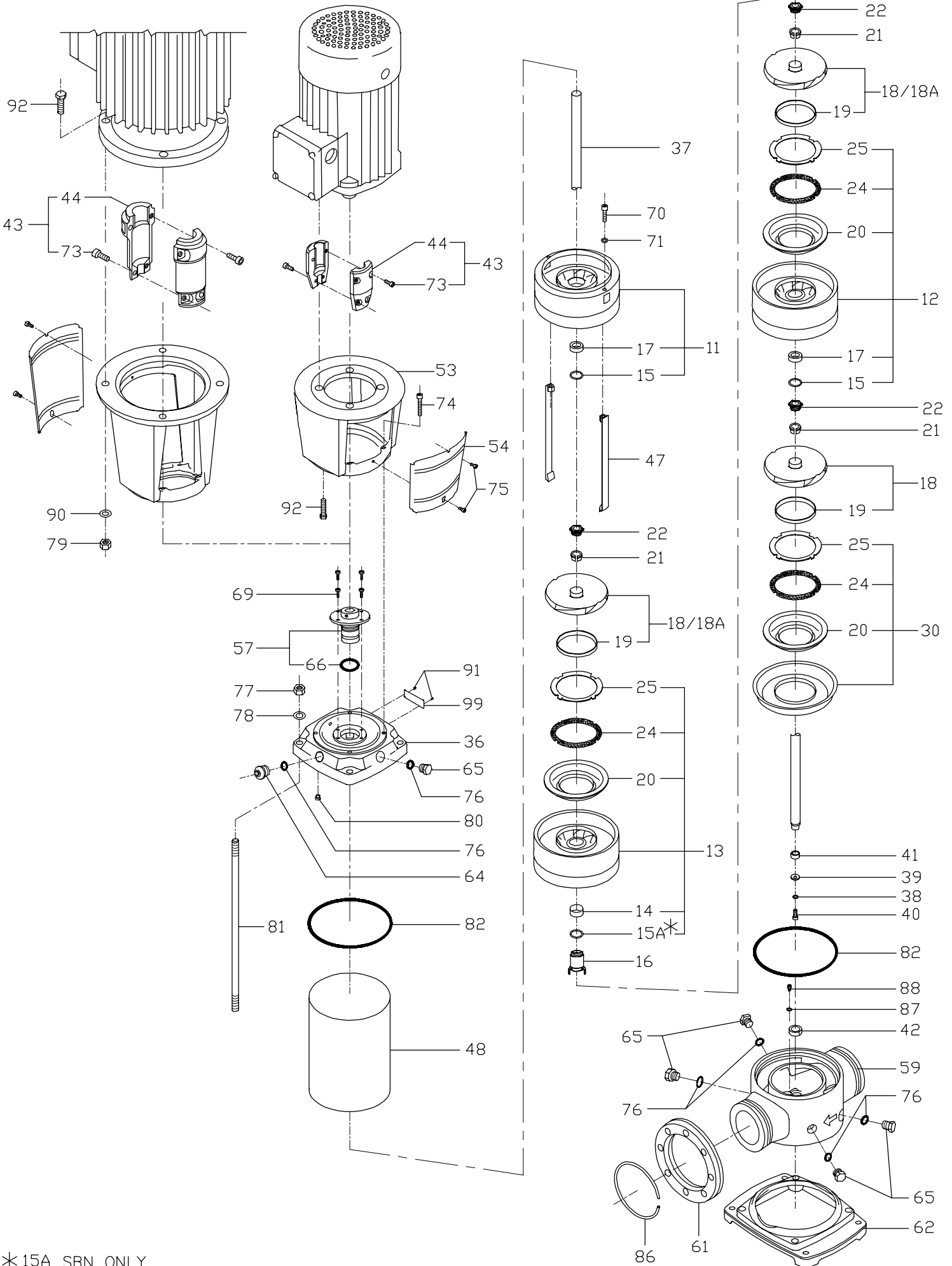

\*15A SBN ONLY

# Drawing For Parts List

# PVMI-PVMX-90

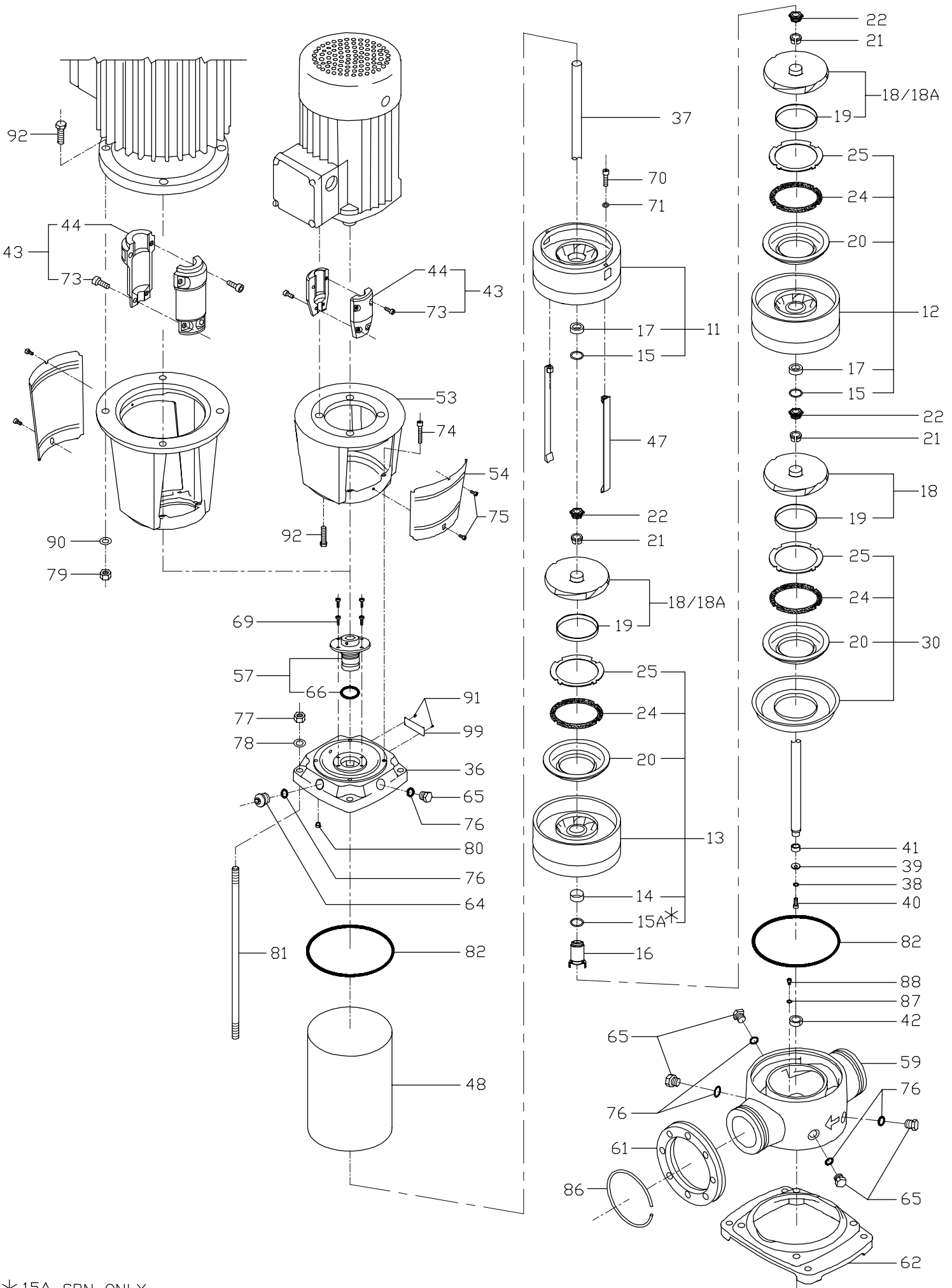

\*15A SBN ONLY